

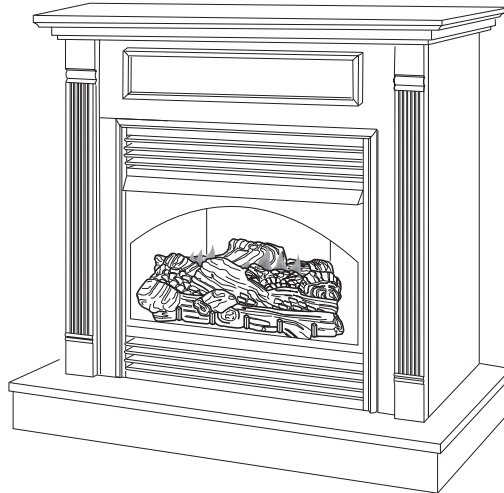

W32TU and W32TO Mantel and Base ASSEMBLY AND INSTALLATION INSTRUCTIONS



IMPORTANT: Read entire instruction sheet before assembling or installing mantel kit.

These mantels are only approved for use with any DESA Heating, LLC 32" electric and gas fireplace systems. Do not use mantel with any other product.

This mantel kit contains the following:

- Mantel pieces - unassembled and numbered as follows:
 - #1 Base
 - #2 Right Side Assembly
 - #3 Left Side Assembly
 - #4 Header
 - #5 Top
- Hardware Package
 - 18 - 1 1/4" Wood Screws 114325-01
 - * Extra hardware may be included

Tools required:

- Power Screwdriver with #2 Phillips Bit

If any wood pieces are missing or damaged, contact the dealer where you purchased this mantel for replacement. If hardware is missing or damaged, contact DESA Heating, LLC at 1-866-672-6040 for referral information. You can also visit DESA Heating, LLC's web site at www.desatech.com.

WARNING: Follow guidelines of paint or finish manufacturer. Use care when finishing or painting an unfinished mantel (W32TU only). Do not finish or paint mantel pieces near running heater or open flame. These vapors are highly flammable.

IMPORTANT: If you are staining an unfinished mantel (W32TU only), remove any sawdust, dirt or oils. This will prevent blemishes from appearing under the stain. Stain mantel before assembling according to manufacturer's instructions. Apply sanding sealer.

IMPORTANT: If you are painting an unfinished mantel (W32TU only), assemble mantel before painting. Follow directions listed on paint for wood products. Apply base coat and top coat following directions listed on product.

Note: Gather all mantel pieces together before assembling mantel.

WARNING: Only use 1 1/4" screws to assemble mantel. Damage to mantel will result if other screws are used for this purpose.

ASSEMBLING MANTEL

IMPORTANT: More than one person is required to lift assembled mantel. Lift mantel by leg assemblies. Lifting by header or mantel top could damage mantel.

Use the following illustrations to assemble mantel. Use only screws provided.

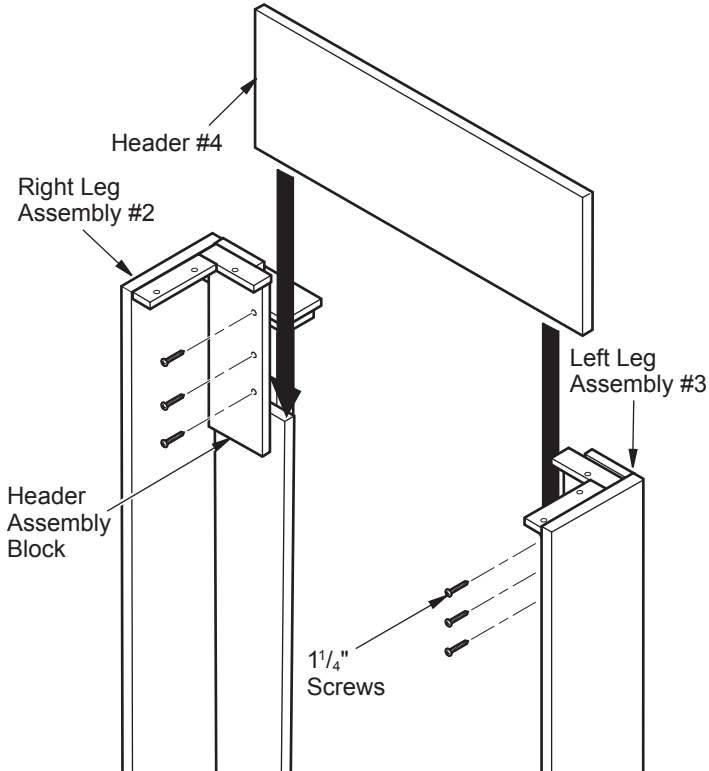

Figure 1 - Installing Header

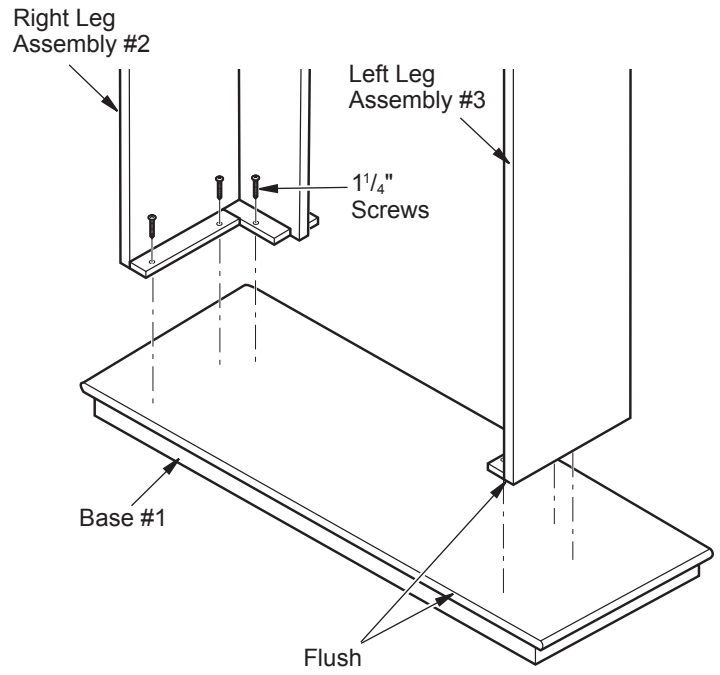

Figure 2 - Installing Mantel Base

IMPORTANT: Align mantel left to right on base before installing. Mantel legs must be flush with back of mantel base before installation. Use a tape measure to insure accuracy.

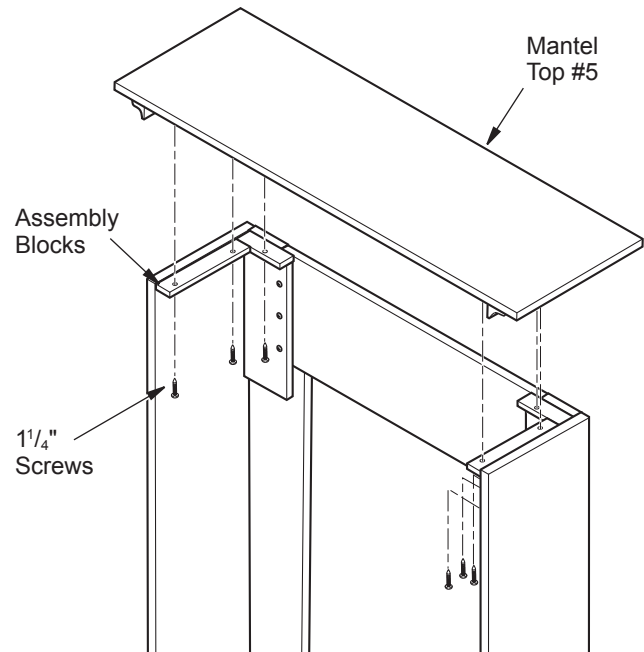

Figure 3 - Installing Top

IMPORTANT: Align mantel top left to right before installing. Back of mantel leg must be flush with back of mantel top before installation.

Gas Fireplace Installation

1. Fireplace should be fully assembled. See Assembling Fireplace in fireplace owner's manual.
2. Place mantel base close to installation location. See fireplace owner's manual for installation clearances. Leave enough room to insert fireplace from back of mantel.
3. Install gas line. See Connecting to Gas Supply in fireplace owner's manual. Remember to leave access to the gas shutoff valve somewhere on the base or where it is accessible to the user.
4. Check for leaks. See Checking Gas Connections in fireplace owner's manual.
5. Position fireplace inside mantel (see Figure 4). Carefully position gas lines. **IMPORTANT:** Use caution when positioning fireplace on base. Base may scratch easily. Make sure fireplace is in proper position within mantel opening before continuing with installation.

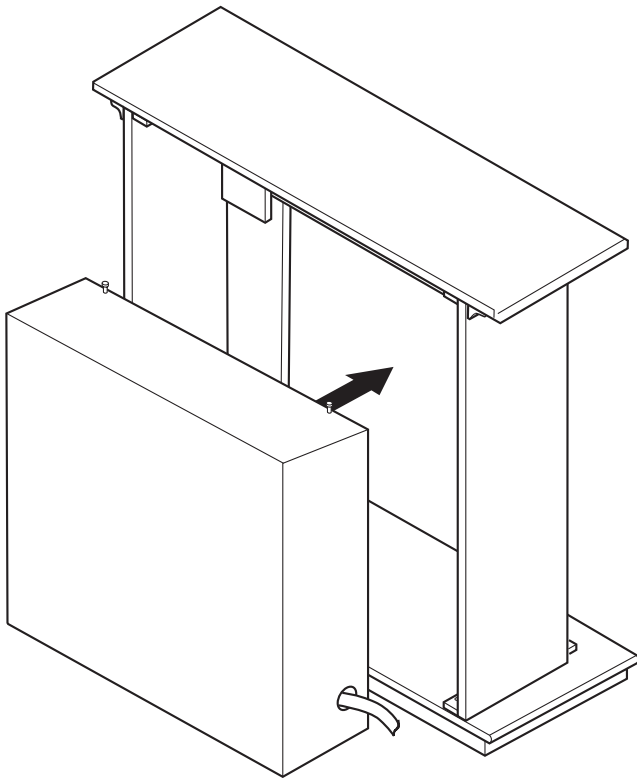

Figure 4 - Installing Gas Fireplace

6. **Fireplace with louver door:** Lower bottom louver door. Use two screws provided in hardware package and attach fireplace to wooden base. Close louver door.
Fireplace with fixed louver: Before installing logs or burner assembly (see owner's manual) remove screws securing floor to assembly. Lift floor for access to bottom of fireplace. Use two screws provided in fireplace hardware package and attach fireplace base to wooden base. Reinstall floor with screws removed previously.
7. Carefully push mantel and base into position against wall.

Electric Fireplace Installation

This mantel can be used with DESA Heating, LLC electric fireplaces. Electric fireplaces install from the front of mantel. To install electric fireplace see fireplace instruction manual.



DESA Heating, LLC
2701 Industrial Drive
Bowling Green, KY 42101
www.desatech.com
1-866-672-6040



123675 01
NOT A UPC

123675-01
Rev. B
07/08